



 **LEXUS**
LED LIGHTS

Bombilla LED igual a la tradicional de incandescencia 100% cristal



Advantages:

- High lumen and high CRI SMD, high light uniformity.
- 98% efficiency glass.

Application:

Widely used in home, hotel and commercial lighting.



Model	Wattage (W)	Voltage (V)	RA	Base	CCT(K)	Lumen	Beam Angle(°)	Surface color
DT-BU-004W-011	4	240V	80	E27	3000-6000	350	360	Silver
DT-BU-005W-008	5	240V	80	E27	3000-6000	430	360	Silver

HIGH CRI LED BULB

DT-BU-005W-011

Bulb Series

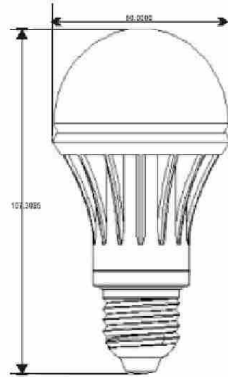

HIGH CRI LED BULB

DT-BU-005W-011

Advantages:

- High lumen and high CRI SMD, high light uniformity.
- 98% efficiency glass.

Application:

Widely used in home, hotel and commercial lighting.



LED
IP 20
PF >0.9
CRI >83
DIM
CE
SAA
RoHS

Model	DIM	Wattage (W)	Voltage (V)	RA	Base	CCT(K)	Lumen	Beam Angle(°)	Surface color
DT-BU-005W-011	Yes	5	240V	70	E27	2800-3200	430	180	Silver
DT-BU-005W-008	Yes	5	240V	70	B22	2800-3200	430	180	Silver
DT-BU-007C-012	Yes	7	240V	70	E27	2800-3200 5500-6500	510 550	180	Silver
DT-BU-007C-012	Yes	7	240V	70	B22	2800-3200 5500-6500	510 550	180	Silver

Spotlight Series



GU 10
MR 16

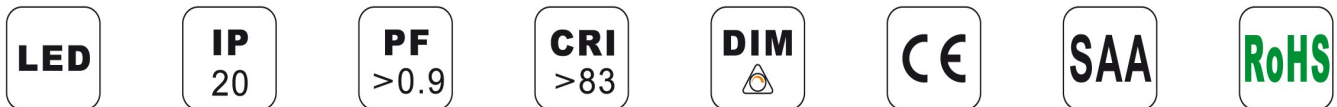
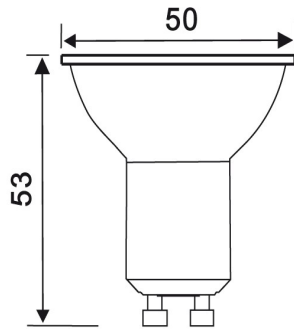

Model	Watt (W)	Voltage (V)	RA	Base	CCT(K)	Beam Angle(°)	Material
PAR16-220-5GU10C	5	AC220V-240V	80	GU10	3000 6500	30/60	Ceramic
PAR16-220-5E27C	5	AC220V-240V	80	E27	3000 6500	30/60	Ceramic
PAR16-220-5GU10P	5	AC220V-240V	80	GU10	3000 6500	30/60	Plastic

Spotlight Series

Angulo de Proyección Ajustable 25°, 40°, 60°



6w = 350 lm

7w = 500 lm

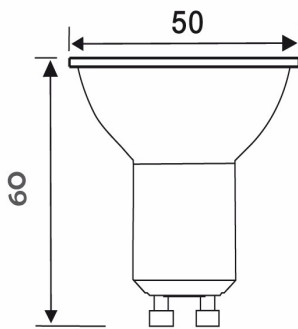

- 1. Patented angle-adjustable design
- 2. Beam angle: 25°, 40°, 55°
- 3. Over 350lm

Model No.	Colour Temperature (K)	Rendering Index (ra)	Luminous Flux (lm)	Efficiency (lm/W)	Beam Angle (°)	Max. Luminous Intensity (cd)	Lamp Life (hrs)	Wattage (W)	Voltage (V)	Frequency (Hz)	Power Factor	Diameter (mm)	Length (mm)	Weight (g)	Lamp Base
LR16-06W-A	2700-6500	80	350	58	25°-40°-55°	400	30,000	6	100-240	50/60	0.9	50	60	60	GU10/GU5.3

Light intensity distribution curve

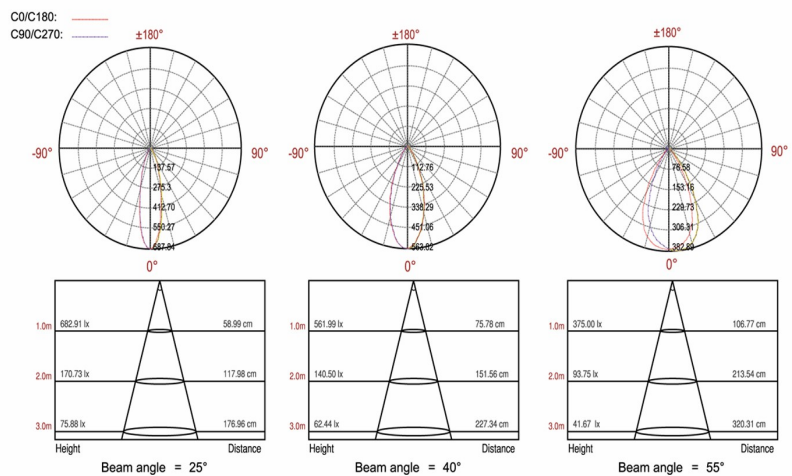

Model	Watt (W)	Voltage (V)	RA	Base	CCT(K)	Beam Angle(°)	Material
220-6GU10	6	AC220V-240V	80	GU10	3000 6500	25/45/60	Aluminium

Spotlight Series



10 w / 950 lumen



15 w / 1450 lumen



GU 10
MR 16

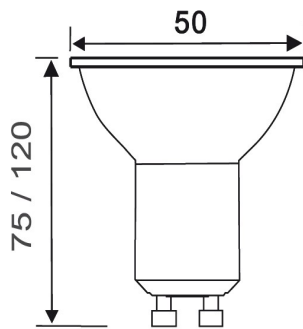

- LED**
- IP**
20
- PF**
>0.9
- CRI**
>83
- DIM**
- CE**
- SAA**
- RoHS**

Model	Watt (W)	Voltage (V)	RA	Base	CCT(K)	Beam Angle(°)	Material
10/15 GU10	10W / 15W	AC 85/260V	80	GU10	3000 6500	30/60	Aluminium
10/15 MR16	10W / 15W	DC 12V	80	MR16	3000 6500	30/60	Aluminium

T5 LED TUBE

T5-A

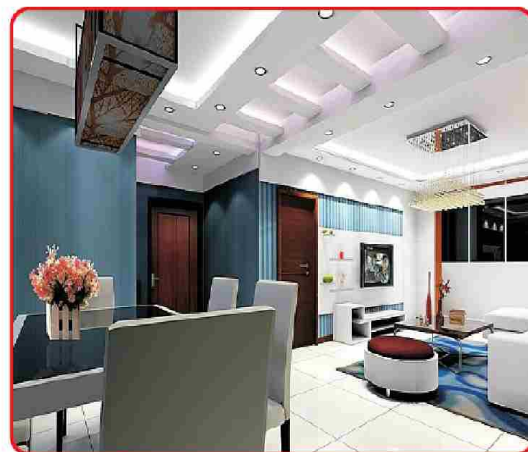

Advantages:

- SMD LED with high efficiency PC diffuser, soft light and eye caring, precise light distribution.
- Aluminium heat sink offer great help to dissipate heat and extend product lifetime.

Application:

Widely used in hotel ,cabinet ,counter, and other commercial lighting places.

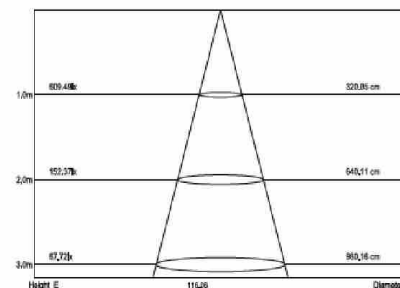
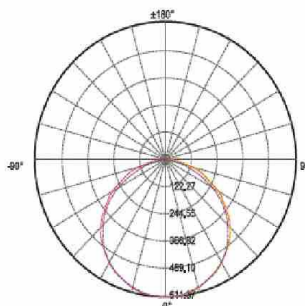

LED

**IP
40**

**PF
>0.9**

**CRI
>83**

CE

RoHS

Model	Wattage (W)	Voltage (V)	LED Qty (pcs)	Lifetime (hrs)	CCT(K)	Lumen	Beam Angle(°)	Size (mm)	Diffuser
T5A4W300	4	110/230	60	40000	2800-3000 3000-3200 4000-4500 5500-6000	300 315 330 350	120	300x16	Clear Opal
T5A8W600	8	110/230	120	40000	2800-3000 3000-3200 4000-4500 5500-6000	600 630 660 700	120	600x16	Clear Opal
T5A12W900	12	110/230	180	40000	2800-3000 3000-3200 4000-4500 5500-6000	1000 1060 1120 1200	120	900x16	Clear Opal
T5A16W1200	16	110/230	240	40000	2800-3000 3000-3200 4000-4500 5500-6000	1200 1280 1320 1400	120	1200x16	Clear Opal

Tube Series

T5 LED TUBE

T5-C



Advantages:

- SMD LED with high efficiency PC diffuser, soft light and eye caring, precise light distribution.
- Aluminium heat sink offer great help to dissipate heat and extend product lifetime.

Application:

Widely used in hotel ,cabinet ,counter, and other commercial lighting places.

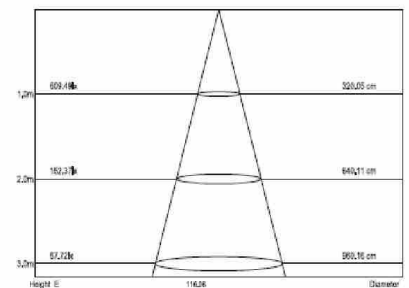
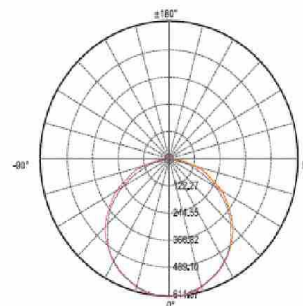

LED

IP
40

PF
>0.9

CRI
>83

CE

RoHS

Model	Wattage (W)	Voltage (V)	LED Qty (pcs)	Lifetime (hrs)	CCT(K)	Lumen	Beam Angle(°)	Size (mm)	Diffuser
T5C8W600	8	110/230	120	40000	2800-3000 4000-4500 5500-6000 6000-6500	600 630 675 700	120	600x16	Clear Opal
T5C12W900	12	110/230	180	40000	2800-3000 4000-4500 5500-6000 6000-6500	1000 1060 1120 1200	120	900x16	Clear Opal
T5C16W1200	16	110/230	240	40000	2800-3000 4000-4500 5500-6000 6000-6500	1200 1280 1320 1400	120	1200x16	Clear Opal
T5C20W1500	20	110/230	300	40000	2800-3000 4000-4500 5500-6000 6000-6500	1400 1480 1540 1600	120	1500x16	Clear Opal
T5C25W1800	25	110/230	360	40000	2800-3000 4000-4500 5500-6000 6000-6500	1700 1825 1920 2000	120	1800x16	Clear Opal

Tube Series

T8 LED TUBE

T8-C



Advantages:

- SMD LED with high efficiency PC diffuser, soft light and eye caring, precise light distribution.
- Aluminium heat sink offer great help to dissipate heat and extend product lifetime.

Application:

Widely used in home ,office ,school and other commercial lighting places.

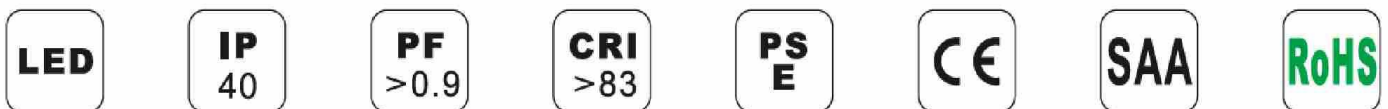
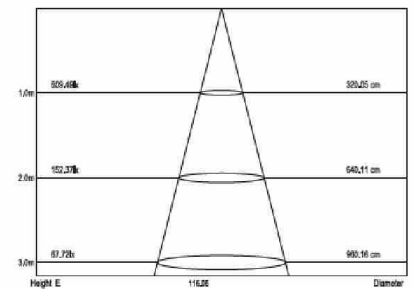
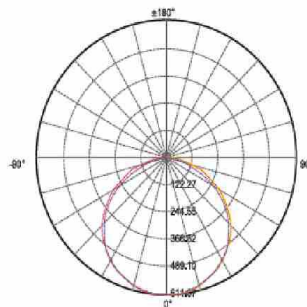

Model	Wattage (W)	Voltage (V)	LED Qty (pcs)	Lifetime (hrs)	CCT(K)	Lumen	Beam Angle(°)	Size (mm)	Diffuser
T810W600-C	10	110/230	144	40000	2800-3000 4000-4500 5500-6000 6000-6500	850 880 910 950	120	600x26	Opal
T812W900-C	12	110/230	192	40000	2800-3000 4000-4500 5500-6000 6000-6500	1000 1050 1100 1150	120	900x26	Opal
T818W1200-C	18	110/230	240	40000	2800-3000 4000-4500 5500-6000 6000-6500	1650 1710 1780 1850	120	1200x26	Opal
T820W1200-C	20	110/230	288	40000	2800-3000 4000-4500 5500-6000 6000-6500	1700 1780 1830 1900	120	1200x26	Opal
T825W1500-C	25	110/230	360	40000	2800-3000 4000-4500 5500-6000 6000-6500	2200 2260 2320 2400	120	1500x26	Opal

Tube Series

T8 LED TUBE

T8-F

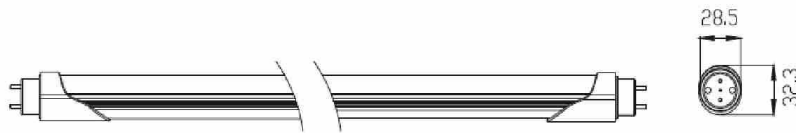

Advantages:

- SMD LED with high efficiency PC diffuser, soft light and eye caring, precise light distribution.
- Aluminium heat sink offer great help to dissipate heat and extend product lifetime.

Application:

Widely used in home ,office ,school and other commercial lighting places.

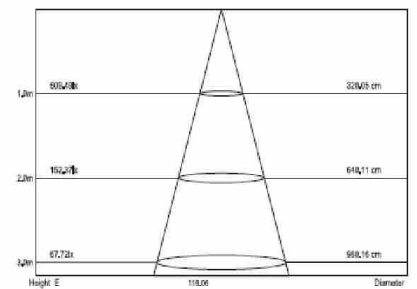
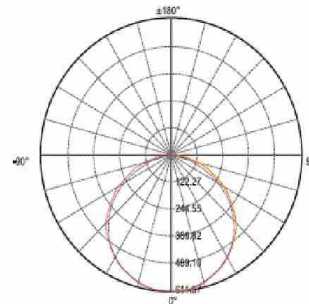

LED
IP 40
PF >0.9
CRI >83
PS E
UL
CE
SAA
RoHS

Model	Wattage (W)	Voltage (V)	LED Qty (pcs)	Lifetime (hrs)	CCT(K)	Lumen	Beam Angle(°)	Size (mm)	Diffuser
T810W600-F	10	100-240 277	96	40000	2800-3000 4000-4500 5500-6000 6000-6500	850 890 920 950	120	600x26x28.5	Clear Opal
T818W1200-F	18	100-240 277	176	40000	2800-3000 4000-4500 5500-6000 6000-6500	1600 1680 1740 1800	120	1200x26x28.5	Clear Opal
T820W1200-F	20	100-240 277	216	40000	2800-3000 4000-4500 5500-6000 6000-6500	1700 1780 1840 1900	120	1200x26x28.5	Clear Opal
T822W1200-F	22	100-240 277	240	40000	2800-3000 4000-4500 5500-6000 6000-6500	1800 1880 1940 2000	120	1200x26x28.5	Clear Opal
T825W1500-F	25	100-240 277	288	40000	2800-3000 4000-4500 5500-6000 6000-6500	2300 2380 2440 2500	120	1500x26x28.5	Clear Opal
T835W1800-F	35	100-240 277	352	40000	2800-3000 4000-4500 5500-6000 6000-6500	3000 3180 3240 3300	120	1800x26x28.5	Clear Opal

Tube Series

T8 LED Tube

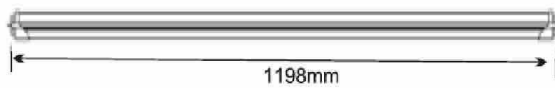

Application:

Widely used in home ceiling, hotel ceiling, shop center ceiling and other commercial lighting places.

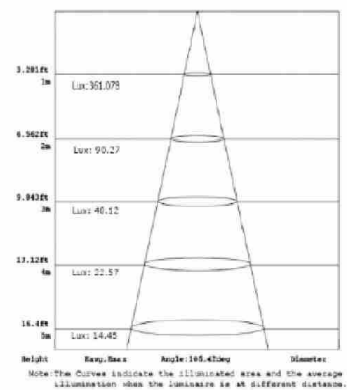
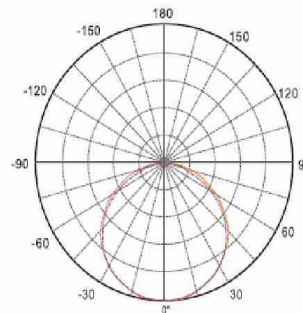

LED
IP 40
PF >0.9
CRI >83
PSE
CE
SAA
RoHS

Model	Wattage (W)	Voltage (V)	LED Qty (pcs)	Lifetime (hrs)	CCT(K)	Lumen	Beam Angle(°)	Size (mm)	Diffuser
TK-T8-LED12W-1200	12	90-277	90	50000-80000	2700-3300	1300	120	26*1200	Opal

Tube Series

T8 LED Sensor Tube

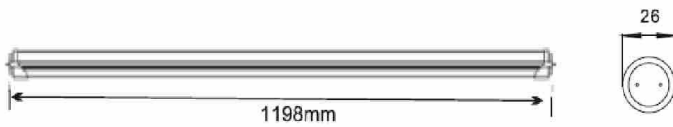
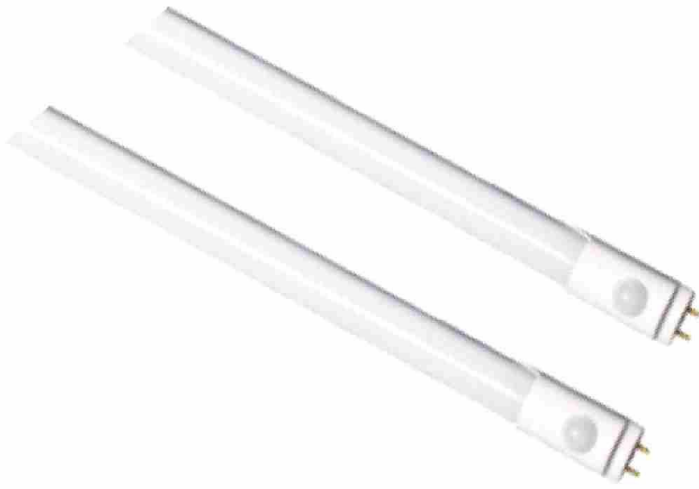

Application:

Widely used in home ceiling, hotel ceiling, shop center ceiling and other commercial lighting places.

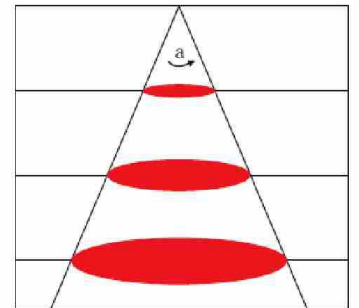
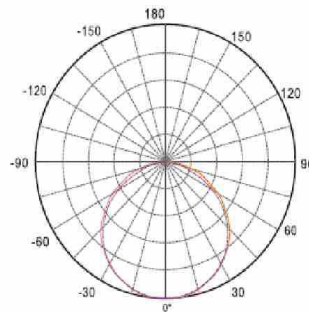

LED
IP 40
PF >0.9
CRI >83
PS E
CE
SAA
RoHS

Model	Wattage (W)	Voltage (V)	LED Qty (pcs)	Lifetime (hrs)	CCT(K)	Lumen	Beam Angle(°)	Size (mm)	Diffuser
SYH-T08-012	12	100-265	108	40000	3000	1400	155-165	26*1200	Opal
DT-T8-018C-007	18	AC100-240	120	40000	5500-6500	1450	140	26*1200	Opal

60° SQUARE COB CEILING LIGHT

CL13-13WF

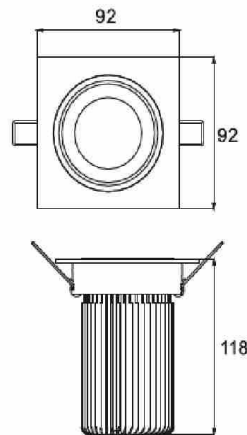

Advantages:

- High efficiency 60° reflector with clear lens, soft light and eye caring, precise light distribution.
- Aluminium heat sink offer great help to dissipate heat and extend product lifetime.

Application:

Widely used in home ceiling ,hotel ceiling, shop center ceiling and other commercial lighting places.

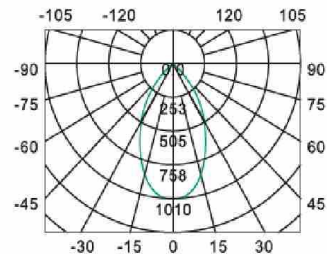

1m	4031.5 lx	75.4cm
2m	1007.9 lx	152.1cm
3m	447.9 lx	228.1cm
4m	251.9 lx	304.1cm
5m	111.9 lx	455.2cm



Model	DIM	Wattage (W)	Voltage (V)	Lifetime (hrs)	CCT(K)	Lumen	Beam Angle(°)	Size (mm)	Surface color
CL13-13WF	Yes	13	110/230	40000	2800-3000 4000-4500 5500-6000	650 700 750	60	ø92*92*118 cut 75	White Silver
CL13-13WF	Yes	13	110/230	40000	2700 3000 4000 5000	820 850 870 900	60	ø92*92*118 cut 75	White Silver

60° ROUND COB CEILING LIGHT

CL13-13W75

CL13-13W90

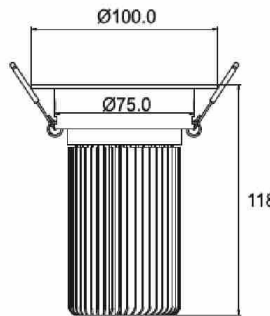

Advantages:

- High efficiency 60° reflector with clear lens, soft light and eye caring, precise light distribution.
- Aluminium heat sink offer great help to dissipate heat and extend product lifetime.

Application:

Widely used in home ceiling, hotel ceiling, shop center ceiling and other commercial lighting places.

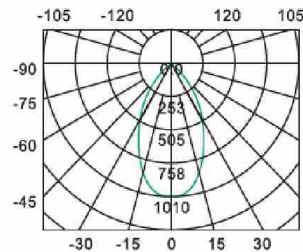

1m	4031.5 lx	75.4cm
2m	1007.9 lx	152.1cm
3m	447.9 lx	228.1cm
4m	251.9 lx	304.1cm
5m	111.9 lx	455.2cm



Model	DIM	Wattage (W)	Voltage (V)	Lifetime (hrs)	CCT(K)	Lumen	Beam Angle(°)	Size (mm)	Surface color
CL13-13W75	Yes	13	110/230	40000	2800-3000 4000-4500 5500-6000	650 700 750	60	Ø85*118 cut 75	White Silver
CL13-13W75	Yes	13	110/230	40000	2700 3000 4000 5000	820 850 870 900	60	Ø85*118 cut 75	White Silver
CL13-13W90	Yes	13	110/230	40000	2800-3000 4000-4500 5500-6000	650 700 750	60	Ø100*118 cut 90	White Silver
CL13-13W90	Yes	13	110/230	40000	2700 3000 4000	820 850 870	60	Ø100*118 cut 90	White Silver

30° HIGH CEILING COB CEILING LIGHT

CL41-15W

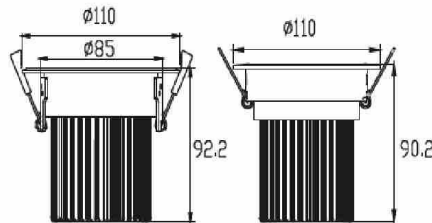

Advantages:

- 30° COB lens ,perfect use to high ceiling,soft light and eye caring,precise light distribution.
- Aluminium heat sink offer great help to dissipate heat and extend product lifetime.

Application:

Widely used in home ceiling ,hotel ceiling ,shop center ceiling and other commercial lighting places.

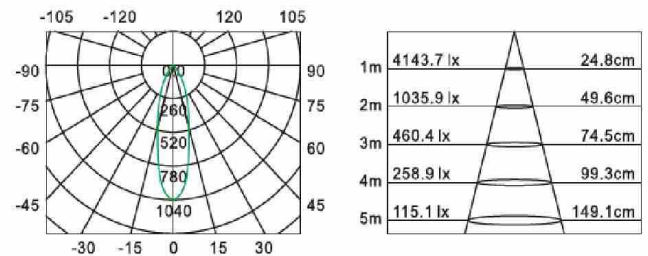

Model	DIM	Wattage (W)	Voltage (V)	Lifetime (hrs)	CCT(K)	Lumen	Beam Angle(°)	Size (mm)	Surface color
CL41-15W	Yes	15	110/230	40000	3000 4000 5000	840 870 910	30	∅110*92 cut 90-95	White Silver
CL41-15W	Yes	15	110/230	40000	3000 4000 5000	840 870 910	30	∅110*90 cut 95-100	White Silver

WATERPROOF COB CEILING LIGHT

CL60-13W
CL60-15W



Advantages:

- Built-in reflector with frosted glass, soft light and eye caring, precise light distribution.
- Professional structure waterproof fixture.

Application:

Widely used in bathroom, corridor or some humid environments etc.

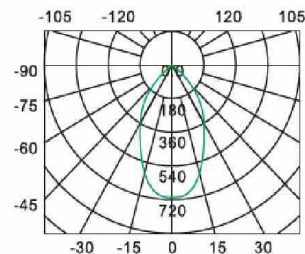

1m	2760.4 lx	57.1cm
2m	690.1 lx	114.3cm
3m	306.7 lx	171.4cm
4m	172.5 lx	228.6cm
5m	76.6 lx	342.9cm



Model	DIM	Wattage (W)	Voltage (V)	Lifetime (hrs)	CCT(K)	Lumen	Beam Angle(°)	Size (mm)	Surface color
CL60-13W	Yes	13	110/230	40000	2700 3000 4000 5000	750 800 850 950	60	∅110*100 cut 90-100	White Silver
CL60-15W	Yes	15	110/230	40000	2700 3000 4000 5000	900 950 1000 1100	60	∅110*113 cut 90-100	White Silver



SMD CEILING LIGHT

CL59-13W
CL59-13WF

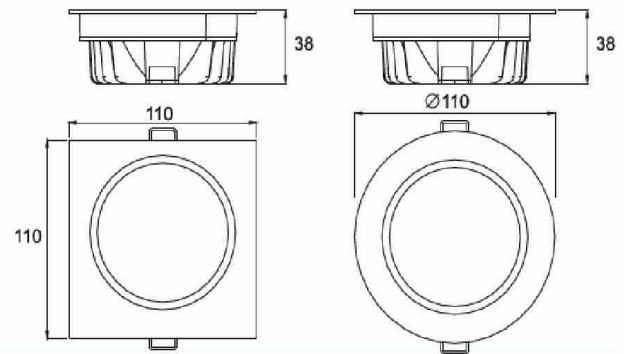

Advantages:

- High efficiency 90° PMMA diffuser downlight, soft light and eye caring, precise light distribution.
- Aluminium heat sink offer great help to dissipate heat and extend product lifetime.

Application:

Widely used in home ceiling, hotel ceiling, shop center ceiling and other commercial lighting places.

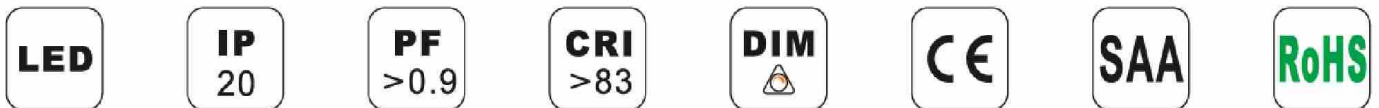
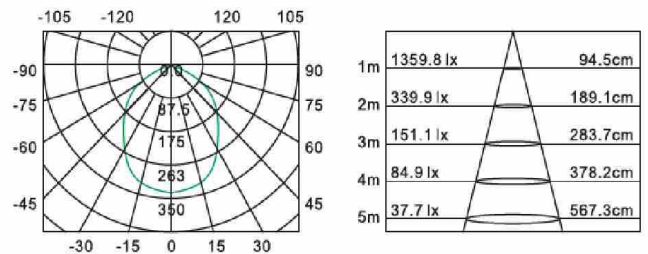

Model	DIM	Wattage (W)	Voltage (V)	Lifetime (hrs)	CCT(K)	Lumen	Beam Angle(°)	Size (mm)	Surface color
CL59-13W	Yes	13	110/230	40000	2700 3000 4000 5000 5700	700 750 800 850 900	90	∅110*38 cut 90-100	White Silver
CL59-13WF	Yes	13	110/230	40000	2700 3000 4000 5000 5700	700 750 800 850 900	90	∅110*110*38 cut 90-100	White Silver

Ceiling light Series



90° REFLECTOR COB CEILING LIGHT

CL35-10W
CL38-15W
CL37-18W

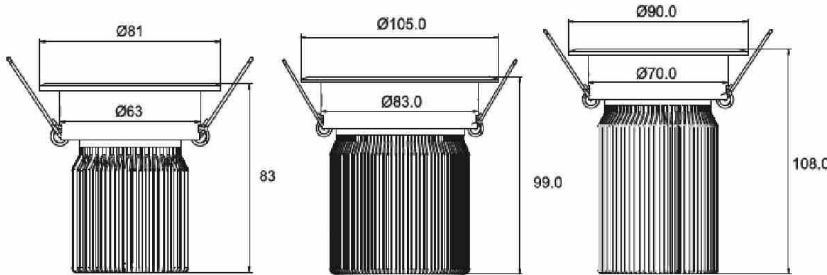

Advantages:

- High efficiency 90° reflector with frosted lens, soft light and eye caring, precise light distribution.
- Aluminium heat sink offer great help to dissipate heat and extend product lifetime.

Application:

Widely used in home ceiling, hotel ceiling, shop center ceiling and other commercial lighting places.

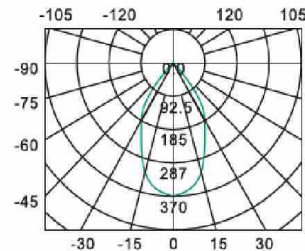

1m	1467.4 lx	55.2cm
2m	366.9 lx	110.4cm
3m	163.1 lx	165.6cm
4m	91.7 lx	220.8cm
5m	40.7 lx	331.2cm



Model	DIM	Wattage (W)	Voltage (V)	Lifetime (hrs)	CCT(K)	Lumen	Beam Angle(°)	Size (mm)	Surface color
CL35-10W	Yes	10	110/230	40000	2800-3000 4000-4500 5500-6000	580 600 650	90	Ø81*83 cut 65-70	White Silver
CL38-15W	Yes	15	110/230	40000	2800-3000 4000-4500 5500-6000	750 800 850	90	Ø90*108 cut 75-80	White Silver
CL37-18W	Yes	18	110/230	40000	2800-3000 4000-4500 5500-6000	900 950 1000	90	Ø105*99 cut 90-95	White Silver

CLASSICAL CEILING LIGHT

CL19-12W
CL3-9W

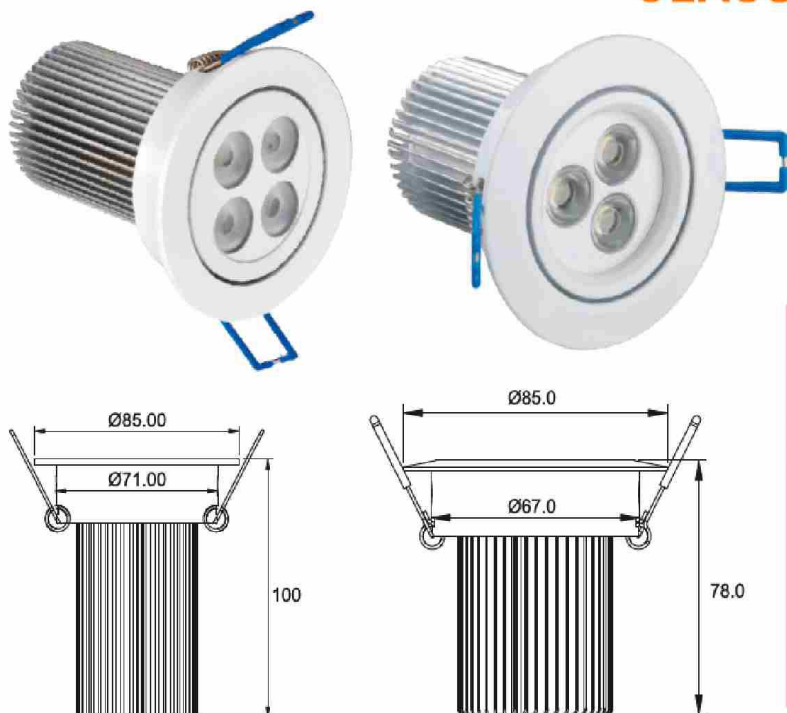

Advantages:

- High efficiency PMMA lens, soft light and eye caring, precise light distribution.
- Aluminium heat sink offer great help to dissipate heat and extend product lifetime.

Application:

Widely used in home ceiling, hotel ceiling, shop center ceiling and other commercial lighting places.

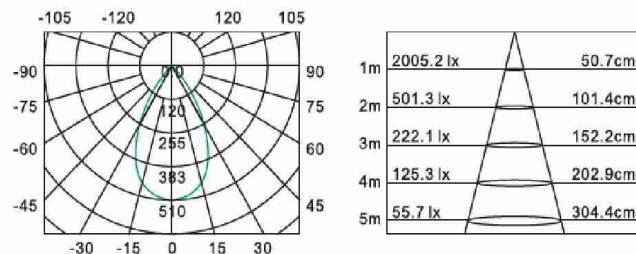

Model	DIM	Wattage (W)	Voltage (V)	Lifetime (hrs)	CCT(K)	Lumen	Beam Angle(°)	Size (mm)	Surface color
CL3-9W	Yes	9	110/230	40000	2800-3000 4000-4500 5500-6000	450 480 500	30 45 60	Ø85*78 cut 80	White Silver
CL19-12W	Yes	12	110/230	40000	2800-3000 4000-4500 5500-6000	600 630 660	30 45 60	Ø85*100 cut 75	White Silver

Grille Light Series

Model	Pictures	Specification	Wattage (W)	Voltage	CCT(K)	Beam Angle(°)	Size (mm)
TF-12081			1*7	AC100-264V	2700 6500	60	145*145*130 Cut:120*120
TF-12082			1*9	AC100-264V	2700 6500	60	185*185*130 Cut:160*160
TF-12083			2*7	AC100-264V	2700 6500	60	275*145*130 Cut:245*120
TF-12084			2*9	AC100-264V	2700 6500	60	370*185*130 Cut:345*160
TF-12085			3*7	AC100-264V	2700 6500	60	390*145*130 Cut:365*120
TF-12086			3*9	AC100-264V	2700 6500	60	500*185*130 Cut:480*160
TF-13087			1*3	AC100-264V	2700 6500	60	95*95*50 Cut:75*75
TF-13088			1*5	AC100-264V	2700 6500	60	120*120*50 Cut:100*100
TF-13089			2*3	AC100-264V	2700 6500	60	175*95*50 Cut:155*75
TF-13090			2*5	AC100-264V	2700 6500	60	230*120*50 Cut:205*100
TF-13091			3*3	AC100-264V	2700 6500	60	255*95*50 Cut:235*75
TF-13092			3*5	AC100-264V	2700 6500	60	335*120*50 Cut:310*100

LED

IP
20

PF
>0.9

CRI
>83



DIM

CE

SAA

RoHS

Ceramic ceiling lamp Series

Model	Photo	Wattage (W)	Voltage (V)	Lifetime (hrs)	CCT(K)	Size (mm)	Material
SP-JTHD-018		3*1	AC85-265	40000	2700-7000	Φ90 cut:60	Ceramic+aluminium
SP-THD-019		3*1	AC85-265	40000	2700-7000	Φ90 cut:60	Ceramic+aluminium
SP-JTHD-020		3*1	AC85-265	40000	2700-7000	Φ93 cut:60	Ceramic+aluminium
SP-JTHD-021		3*1	AC85-265	40000	2700-7000	Φ93 cut:60	Ceramic+aluminium
SP-JTHD-022		3*1	AC85-265	40000	2700-7000	93*93 cut:60	Ceramic+aluminium
SP-JTHD-024		3*1	AC85-265	40000	2700-7000	Φ115 cut:60	Ceramic+aluminium

LED

IP
20

PF
>0.9

CRI
>83

DIM

CE

SAA

RoHS

Downlight Series

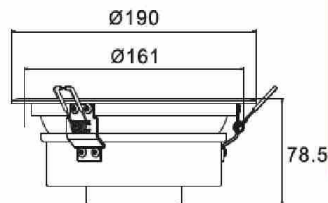
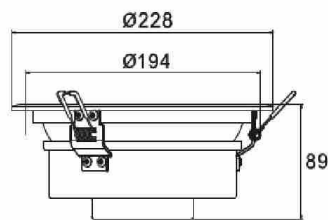

SMD DOWNLIGHT

DL02-15W
DL02-20W
DL02-28W



Advantages:

- High lumen SMD led with PMMA diffuser, soft light and eye caring, precise light distribution.
- Aluminium heat sink offer great help to dissipate heat and extend product lifetime.

Application:

Widely used in home ceiling ,hotel ceiling, shop center ceiling and other commercial lighting places.

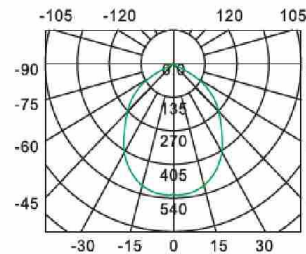

1m	2140.5 lx	92.1cm
2m	535.1 lx	184.2cm
3m	237.8 lx	267.3cm
4m	133.7 lx	368.4cm
5m	59.4 lx	552.7cm

LED

IP
20

PF
>0.9

CRI
>83

DIM

CE

SAA

RoHS

Model	DIM	Wattage (W)	Voltage (V)	Lifetime (hrs)	CCT(K)	Lumen	Beam Angle(°)	Size (mm)	Surface color
DL02-15W	Yes	15	110/230	40000	2800-3000 4000-4500 5500-6000	1100 1150 1200	120	Ø 190*78.5 cut 170-180	White Silver
DL02-20W	Yes	20	110/230	40000	2800-3000 4000-4500 5500-6000	1500 1550 1600	120	Ø 190*78.5 cut 170-180	White Silver
DL02-28W	Yes	28	110/230	40000	2800-3000 4000-4500 5500-6000	2200 2250 2300	120	Ø 228*89 cut 200-210	White Silver

FULL SIZE DOWNLIGHT DL06



Advantages:

- High lumen SMD led with PMMA diffuser, soft light and eye caring, precise light distribution.
- Aluminium heat sink offer great help to dissipate heat and extend product lifetime.

Application:

Widely used in home ceiling , hotel ceiling, shop center ceiling and other commercial lighting places.

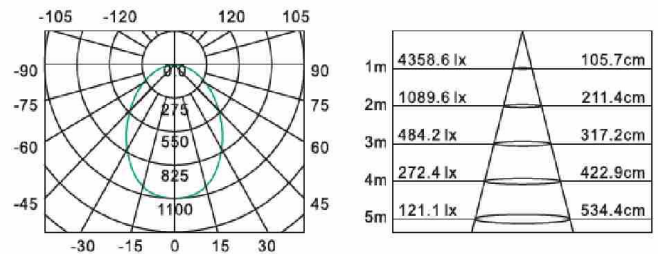

LED

IP
20

PF
>0.9

CRI
>83

DIM

CE

SAA

RoHS

Model	DIM	Wattage (W)	Voltage (V)	Lifetime (hrs)	CCT(K)	Lumen	Beam Angle(°)	Size (mm)	Surface color
DL06-13W	Yes	13	110/230	40000	2700 3000 4000 5000 5700	670 720 768 825 900	90	∅125*50 cut 110-115	White
DL06-18W	Yes	18	110/230	40000	2700 3000 4000 5000 5700	1130 1210 1317 1390 1450	90	∅145*52 cut 130-135	White
DL06-25W	Yes	25	110/230	40000	2700 3000 4000 5000 5700	1488 1625 1744 1795 1860	90	∅190*78 cut 170-180	White
DL06-33W	Yes	33	110/230	40000	2700 3000 4000 5000 5700	2034 2230 2388 2505 2690	90	∅225*93 cut 200-210	White



REFLECTOR LENS COB DOWNLIGHT

DL09-26W
DL10-26W
DL11-35W

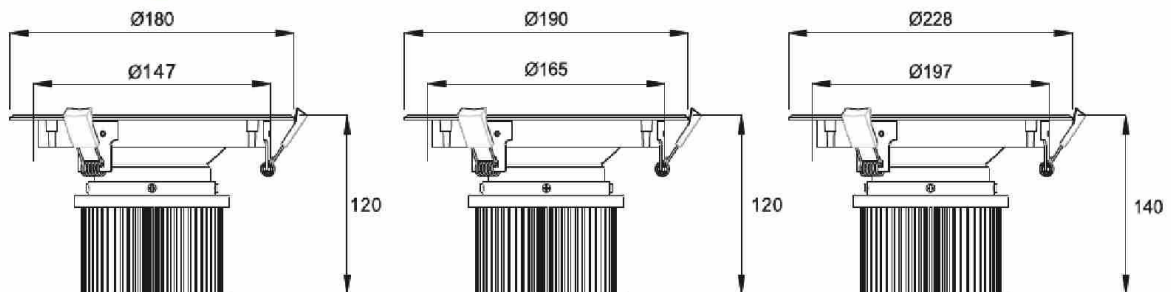

Advantages:

- High efficiency lens without glaring and high efficiency reflector, soft light and eye caring, precise light distribution.
- Aluminium heat sink offer great help to dissipate heat and extend product lifetime.

Application:

Widely used in home ceiling, hotel ceiling, shop center ceiling and other commercial lighting places.

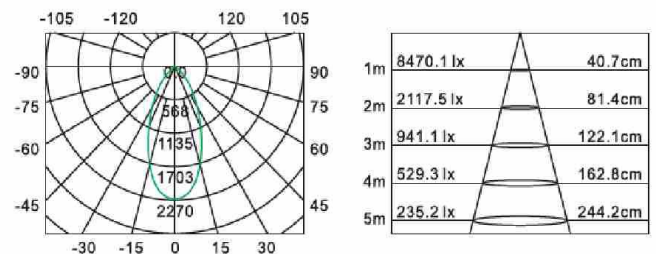

Model	DIM	Wattage (W)	Voltage (V)	Lifetime (hrs)	CCT(K)	Lumen	Beam Angle(°)	Size (mm)	Surface color
DL09-26W	Yes	26	110/230	40000	2700 3000 4000 5000	1612 1638 1716 1846	45	Ø180*120 cut 150-160	White Silver
DL10-26W	Yes	26	110/230	40000	2700 3000 4000 5000	1560 1612 1664 1768	45	Ø190*120 cut 170-180	White Silver
DL11-35W	Yes	35	110/230	40000	2700 3000 4000 5000	2100 2170 2240 2380	45	Ø228*140 cut 200-210	White Silver

ROUND LED PANEL

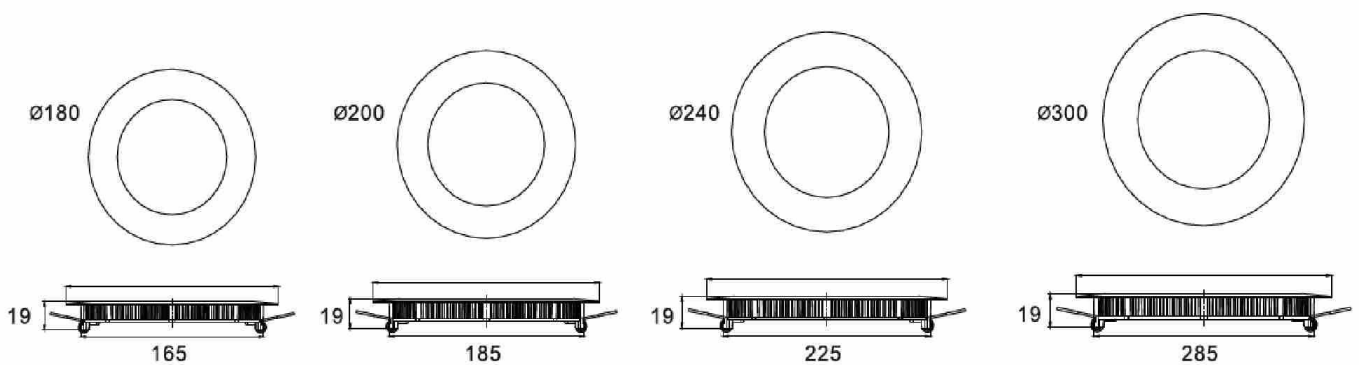

Advantages:

- High lumen SMD led with PMMA diffuser, soft light and eye caring, precise light distribution.
- Aluminium heat sink offer great help to dissipate heat and extend product lifetime.

Application:

Widely used in home ,office ,school and other commercial lighting places.

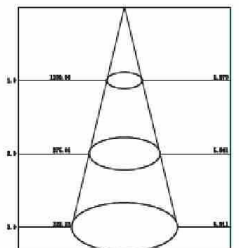
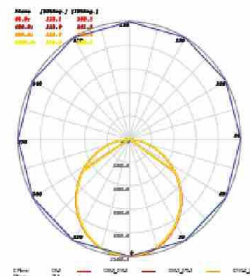

LED

IP
40

PF
>0.9

CRI
>83

CE

SAA

RoHS

Model	Watt (W)	Voltage (V)	LED Qty (pcs)	Lifetime (hrs)	CCT(K)	Lumen	Beam Angle(°)	Size (mm)	Surface color
PL1819-10W	10	100-240	108	40000	2800-3000 4000-4500 5500-6000 6000-6500	550-600	120	180*19	White Silver
PL2019-10W	10	100-240	132	40000		550-600	120	200*19	White Silver
PL2419-15W	15	100-240	150	40000		800-900	120	240*19	White Silver
PL3019-20W	20	100-240	180	40000		1200-1400	120	300*19	White Silver

Panel Series



SQUARE LED PANEL

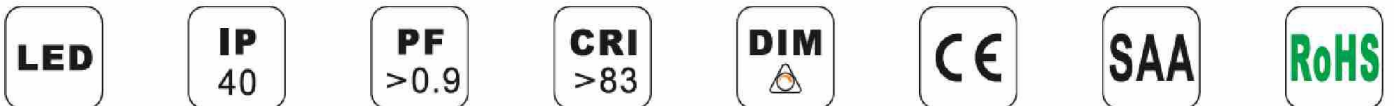

Model	DIM	Watt (W)	Voltage (V)	LED Qty (pcs)	Lifetime (hrs)	CCT (K)	Lumen	Beam Angle(°)	Size (mm)	Surface color
PL3030-18W-C	Yes	18	110/230	48	40000	2700 3000 4000 5000 5700 6500	1200-1300	120	295*295*10.8	White Silver
PL3030-36W-C	Yes	36	110/230	72	40000		2700-2900	120	295*295*10.8	White Silver
PL3060-36W-C	Yes	36	110/230	80	40000		2600-2800	120	295*595*10.8	White Silver
PL6060-45W-C	Yes	45	110/230	96	40000		3200-3400	120	595*595*10.8	White Silver
PL6060-56W-C	NO	56	100-240	128	40000		3400-3600	120	595*595*10.8	White Silver
PL6060-72W-C	NO	72	100-240	160	40000		4500-4700	120	595*595*10.8	White Silver
PL6262-56W-C	NO	56	100-240	128	40000		3400-3600	120	615*615*10.8	White Silver
PL30120-45W-C	Yes	45	110/230	128	40000		3300-3500	120	295*1195*10.8	White Silver
PL30120-56W-C	NO	56	100-240	128	40000		3400-3600	120	295*1195*10.8	White Silver
PL30120-72W-C	NO	72	100-240	160	40000		4500-4700	120	295*1195*10.8	White Silver
PL60120-72W-C	NO	72	100-240	160	40000		4500-4700	120	595*1195*10.8	White Silver

High Bay Light Series

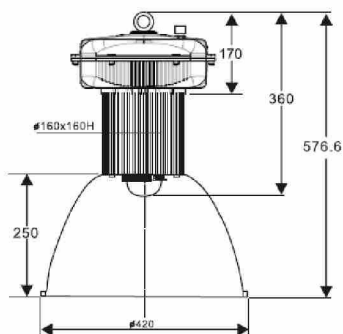

Applications:

workshop, Warehouse, Toll House, Supermarket, Exhibition Centre, Stadium, Shipyard, Mine

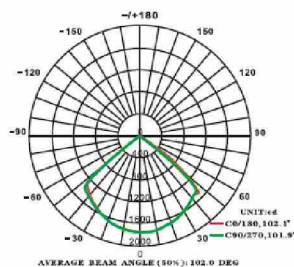

1m	4143.7 lx	24.8cm
2m	1035.9 lx	49.6cm
3m	460.4 lx	74.5cm
4m	258.9 lx	99.3cm
5m	115.1 lx	149.1cm



Model	Wattage (W)	Voltage (V)	Lumen	CRI	PF	Beam Angle(°)	Size (mm)	Surface color
TDL-K70006-100	100	100-245V	8100	RA 75	0.95	60	475*474mm	White
TDL-K70002-120	120	100-245V	9920	RA 75	0.95	60	475*550mm	White
TDL-K70007-150	150	100-245V	11250	RA 75	0.95	60	475*550mm	White

LEDXUS

High Bay Light Series

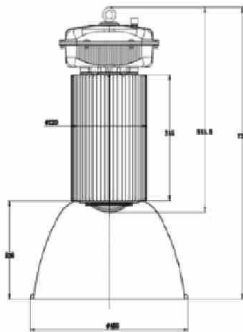

Applications:

workshop, Warehouse, Toll House, Supermarket, Exhibition Centre, Stadium, Shipyard, Mine

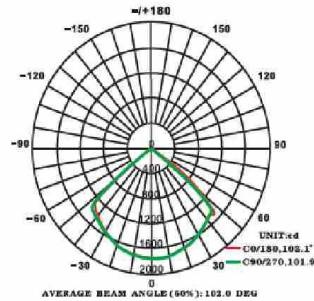

1m	2760.4 lx	57.1cm
2m	690.1 lx	114.3cm
3m	306.7 lx	171.4cm
4m	172.5 lx	228.6cm
5m	76.6 lx	342.9cm

LED	IP 54	PF >0.9	CRI >83	DIM 	CE	SAA	RoHS
------------	-----------------	-------------------	-------------------	----------------	-----------	------------	-------------

Model	Wattage (W)	Voltage (V)	Lumen	CRI	PF	Beam Angle(°)	Size (mm)	Surface color
TDL-K70008-180	180	AC100-240V	13000-15000	RA 75	0.95	60	460*H737mm	White
TDL-K70009-200	200	AC100-240V	15000-17600	RA 75	0.95	60	460*H737mm	White

Floodlight Series



FLOODLIGHT

FL5W
FL10W
FL20W
FL30W
FL40W
FL50W
FL80W

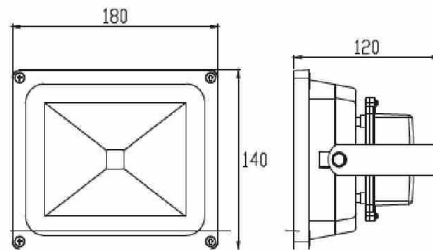

Advantages:

- High lumen COB led ,high light intensity and uniformity.
- Professional structure waterproof fixture.

Application:

Widely used in garden,corridor or some humid environments etc.

LED

IP
65

PF
>0.9

CRI
>83

CE

SAA

RoHS

Model	Wattage (W)	Voltage (V)	Input Current	Lifetime (hrs)	CCT(K)	Lumen	Beam Angle(°)	Surface color
FL5W	5	DC24V AC100-240V	106mA	40000	3000-3200 5700-6200	480 500	120	Black Gray
FL10W	10	DC24V AC100-240V	106mA	40000	3000-3200 5700-6200	950 1000	120	Black Gray
FL20W	20	DC24V AC100-240V	230mA	40000	3000-3200 5700-6200	1700 1800	120	Black Gray
FL30W	30	DC24V AC100-240V	330mA	40000	3000-3200 5700-6200	2400 2500	120	Black Gray
FL40W	40	DC24V AC100-240V	450mA	40000	3000-3200 5700-6200	3100 3200	120	Black Gray
FL50W	50	AC100-240V	525mA	40000	3000-3200 5700-6200	3900 4000	120	Black Gray
FL80W	80	AC100-240V	860mA	40000	3000-3200 5700-6200	6400 6500	120	Black Gray

LED Ground Lamp

Applications:

With Strong IP Grade, LED Ground Lamp is Widely applies in Building, staircase lighting, pavement, entertainment center, roof garden, basement, city square, vehicle road, park, ...



LJC-1255
LJC-1217
LJC-1213
LJC-1220
LJC-1265



Model	Picture	Wattage (W)	Voltage (V)	Color	CCT(K)	Lumen	Beam Angle (°)	Size (mm)	IP
LJC-1255		3	AC12V	Red/Yellow/blue/white/warm white Green RGB	R:625NM Y:290NM B:470NM G:530NM W:6000-7000K WW:2700-3500K	315	15-60 Optional	φ100*75	IP 67
LJC-1217		5	AC24V	Red/Yellow/blue/white/warm white Green RGB	R:625NM Y:290NM B:470NM G:530NM W:6000-7000K WW:2700-3500K	525	15-60 Optional	φ120*90	IP 67
LJC-1213		3	AC12V	Red/Yellow/blue/white/warm white Green RGB	R:625NM Y:290NM B:470NM G:530NM W:6000-7000K WW:2700-3500K	315	15-60 Optional	φ100*65	IP 65
LJC-1220		6	AC24V	Red/Yellow/blue/white/warm white Green RGB	R:625NM Y:290NM B:470NM G:530NM W:6000-7000K WW:2700-3500K	525	15-60 Optional	φ150*60	IP 65
LJC-1265		5	AC24V	Red/Yellow/blue/white/warm white Green	R:625NM Y:290NM B:470NM G:530NM W:6000-7000K WW:2700-3500K	525	15-60 Optional	φ 140*140*60	IP 65

Healthy
Living



Take Care of the Planet



LEDXUS
Green make your life better

RoHS
compliant



Ledxus co ltd ,Pontygridd, Glamorgan,United Kindom, CF 372EE